

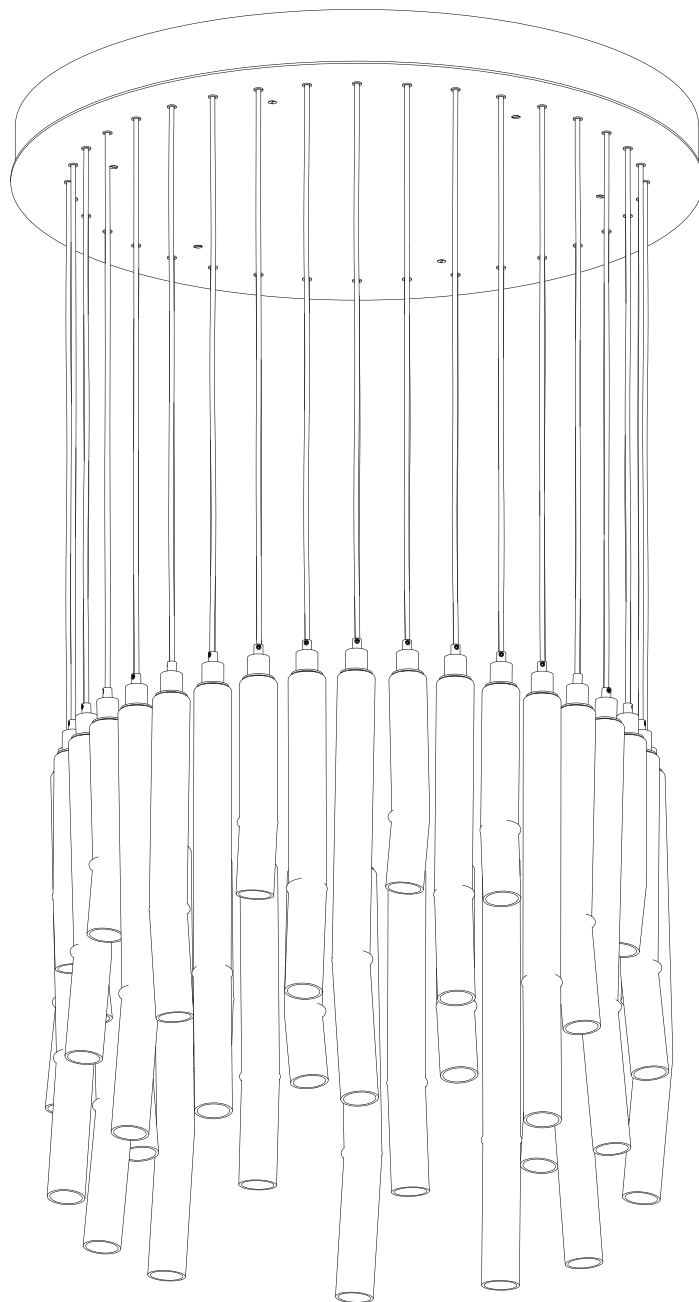

# FOLD ROUND 36 CHANDELIER

## Installation Instructions



**SkLO**

sklo.com

SkLO US 115 WEST NORTH STREET HEALDSBURG CALIFORNIA 95448 USA +1.707.385.2101 us@sklo.com  
SkLO EU VÁŽNÍ 488 500 03 HRADEC KRÁLOVÉ CZECH REPUBLIC +420.495.542.071 eu@sklo.com



# FOLD ROUND 36 CHANDELIER





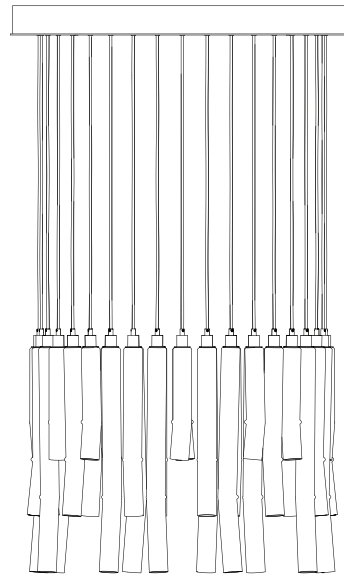

Congratulations on your purchase of a SkLO Fold Round 36 Chandelier. This product must be installed in accordance with the applicable codes by a person familiar with the construction and operation of the product and the hazards involved, preferably a licensed electrician. Use a maximum 7W bulb.

**When unpacking individual items and parts of the light fixture, make sure to lay them out on a protective surface that will neither mar the delicate metal finishes nor scratch the glass. Gloves (nitrile) are provided and must be worn during installation to avoid fingerprints on the finish of the exposed metal parts.**

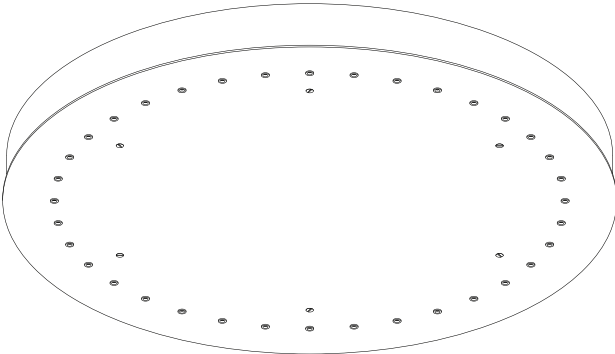
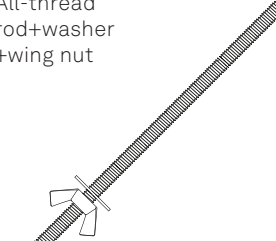
Your SkLO fixture will arrive with the hand-blown glass elements packed separately from the light fixture itself.

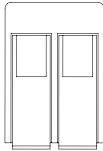
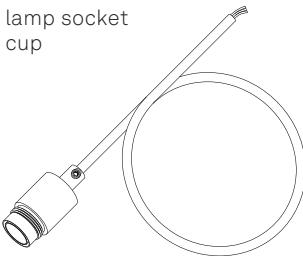
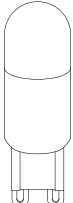

## CONTENTS:

Canopy+ mounting plate	All-thread rod+washer +wing nut	Strain relief	Wire connector
			
	Cord+ lamp socket cup	6x	36x
		Glass -large	38x
Light bulb	Glass -small	1x	36x
		Glass -medium	
	36x	12x	12x
			
		12x	12x



1. The mounting plate will arrive fastened to the canopy. Separate the mounting plate from the canopy by carefully removing the four machine screws and set these aside for use during final installation (Figure 1).

NOTE: There are steel cables attached to the mounting plate. The other ends of the cables will be attached to the top of the canopy during this installation. These support cables are provided as part of a UL requirement that allows the fixture to be temporarily suspended independent of the electrical cables/connections for inspection. Remove the glass elements before any such inspection or any other case in which the fixture will be supported by these cables alone.

2. Position the mounting plate over the recessed electrical box in a way that the central opening in the plate and the box are aligned. Determine the final desired position and orientation of the fixture. Fasteners/anchors (not provided) that are appropriate to the ceiling material being fastened to and in adequate number to support the approximate 200 lbs weight of the fixture must be installed using some or all the holes (Figure 2).
3. Fully thread each of the provided four nylon all-thread rods into each of the four threaded stand-offs on the mounting plate and slide the canopy up and over the rods such that each rod passes through the appropriate hole in the canopy. One at a time, slide a nylon washer up over each rod and thread on a wing nut so that the canopy can rest on the four washers. Level the canopy (Figure 3).
4. Determine the desired length of each cord and trim each one, making sure to leave enough additional length to make the wiring connections within the canopy. When trimming the fabric-wrapped electrical cords make sure to use electrical tape or other means to secure the fabric at the location of the cut, and then at the cut end to avoid splaying, fraying, or slack in the fabric. Pass the fabric-wrapped electrical cord through the hole in the canopy. Slide plastic strain relief over the end of the cord and fix the length of the cord by tightening the set screw – do not overtighten or damage the electrical cord and insulation (Figure 4).

5. With the fixture composition in place, and while the fixture is still supported on the nylon all-thread rods, connect the exposed leads of the fixture to the exposed leads in the electrical box, following the wiring diagram and using the provided wire connectors. Attach the ground (TE) wires to ground (TE) wires of the light fixture, phase 1 (L1) to phase 1 (L1) of the light fixture, neutral (N) to neutral (N) of the light fixture (Figure 5). Please note the number and type of wire connectors may vary.
6. Attach each support cable to the loop on the inside/top of the canopy using the provided quick-link at the free end of the cable (Figure 6).
7. Raise the canopy and carefully supported fixture up the nylon all-thread rods all the way flush to the ceiling, taking care that no electrical cables or connections are exposed where the canopy meets the ceiling. Working one at a time, remove a nylon all-thread rod and insert one of the provided machine screws through the countersunk hole in the canopy into the corresponding threaded stand-off on the mounting plate above (Figure 7). Take great care when installing screws so that tools do not slip and scratch the canopy finish, or damage the exposed screw head slots.
8. Unwrap the protective packaging from each of the 36 individual pendants. Install the supplied LED light bulbs (7W Max) into the sockets. This fixture uses G9 sockets and light bulbs. The G9 is a bi-pin socket. Light bulbs are to be inserted and removed by pushing the bulb straight into the socket, and by pulling it straight out. The bulb, when inserted, should have a tight fit. Do not force the bulb. If there is resistance, check to make sure nothing inside the socket is bent or obstructing the bulb. Always turn off the power to the fixture when changing the bulb(s). Unwrap and lay out all individual glass diffusers. Carefully thread a glass diffuser onto each socket (Figure 8). Thread on the glass diffusers just until they are visually tight – do not overtighten.

Please note that some parts of the Fold Round 36 differ in size from the parts depicted on the following pages. However, the installation procedure is the same for all models in the Fold Round family.



1.

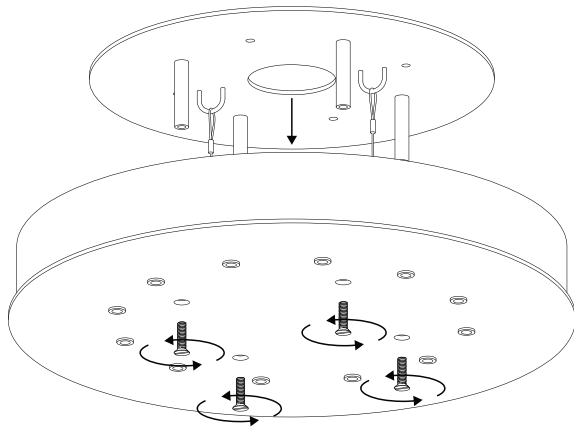

2.

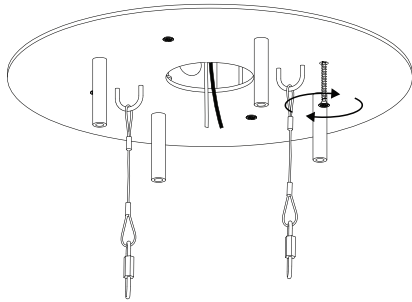

3.

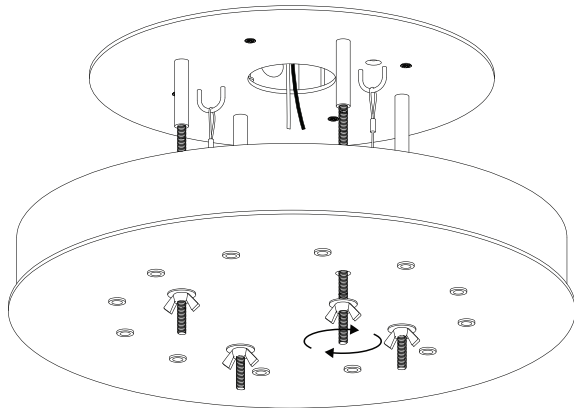

4.

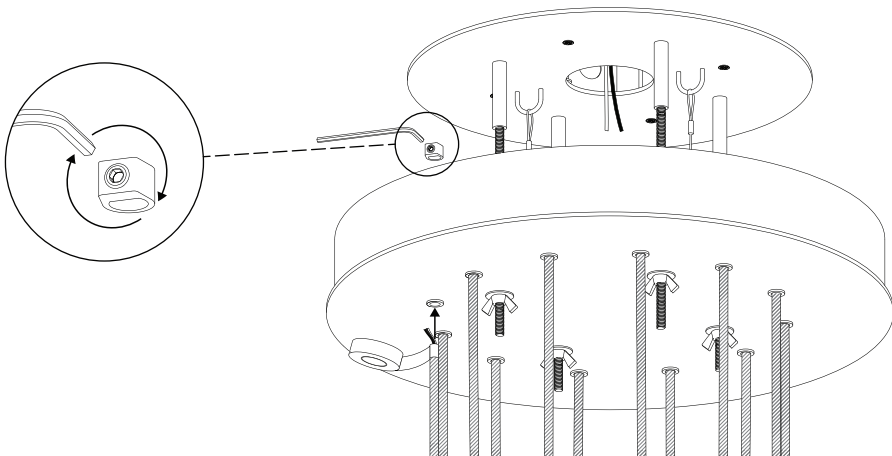



5.

GROUND

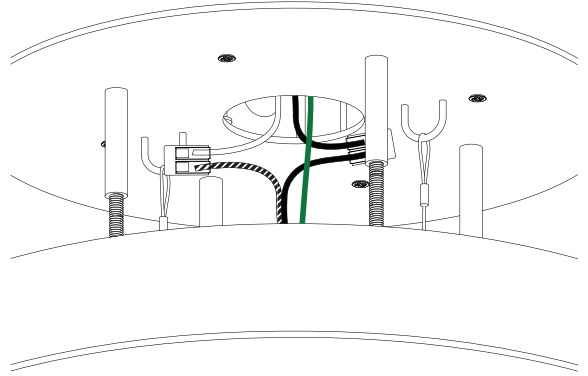
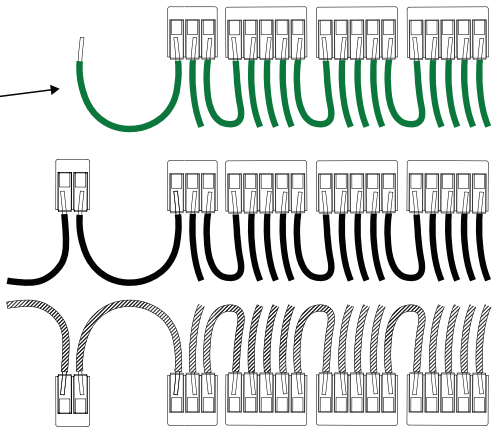

6.

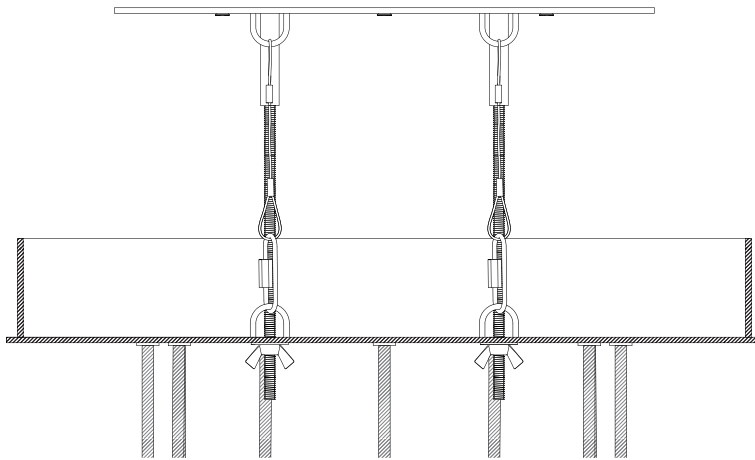

7.

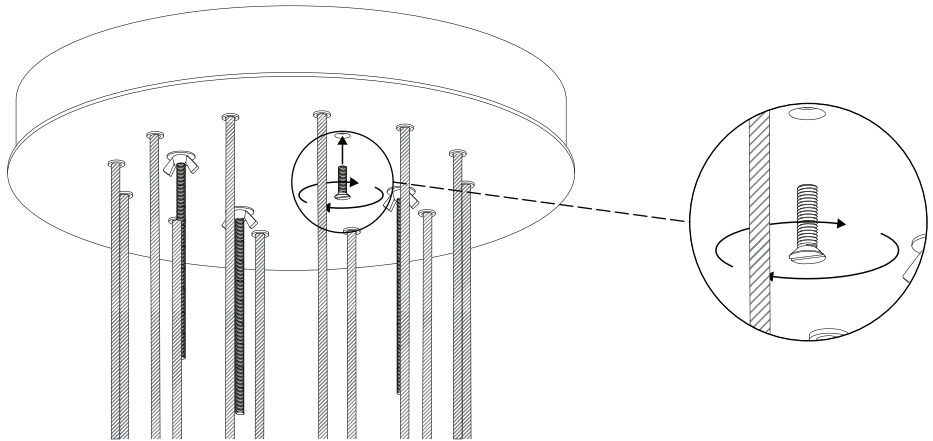

8.

